

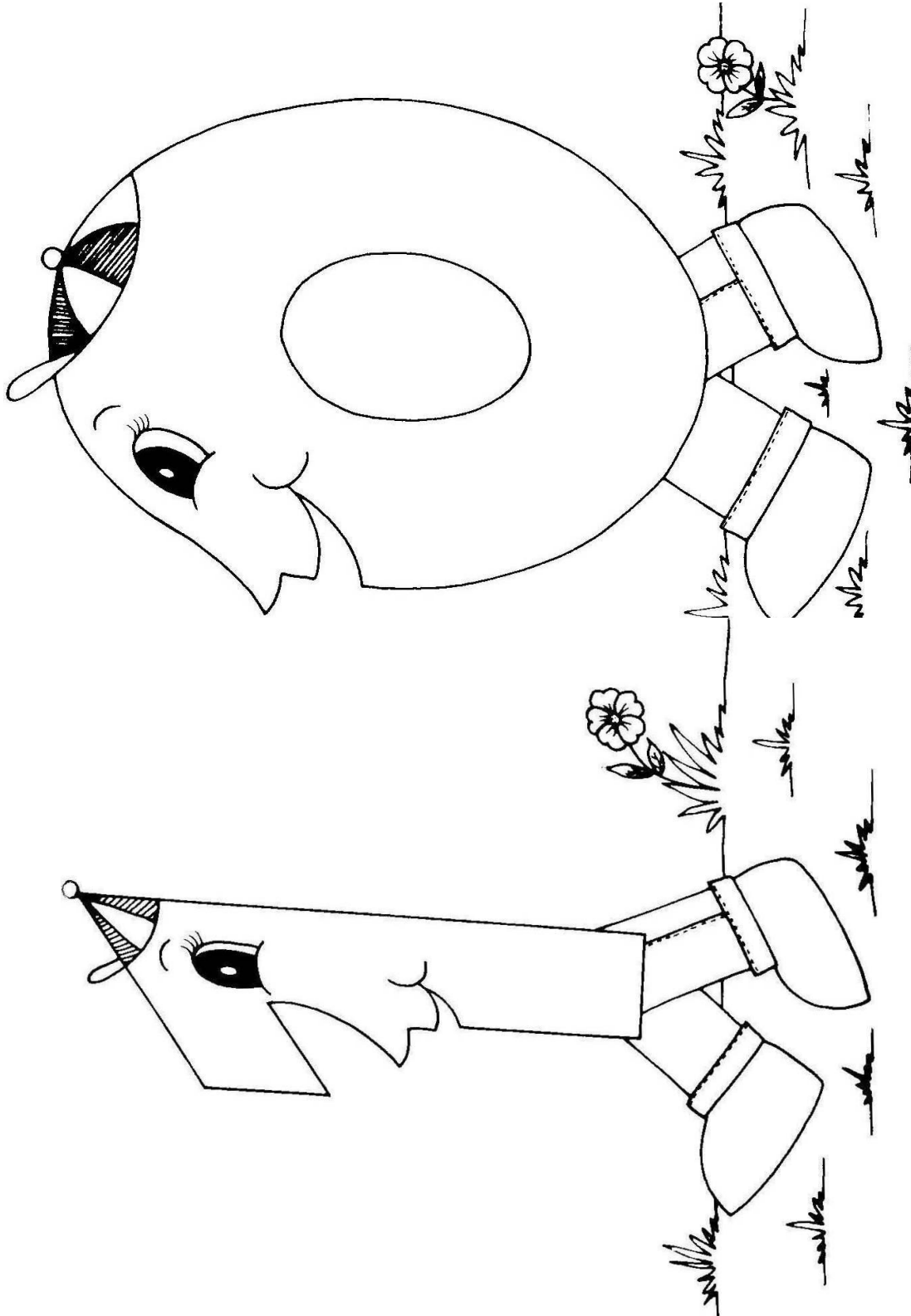

EL NUMERO 10

- Decoro el número diez.



NÚMERO DIEZ

- Pego frijolitos en el número 10.
- Hago puntitos con t mpera en los hipop tamamos.

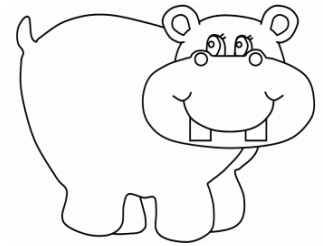
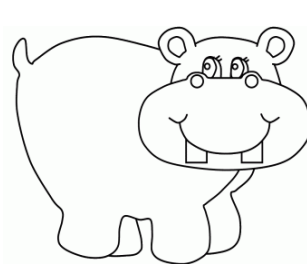
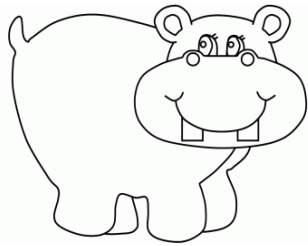
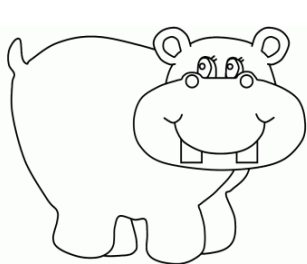
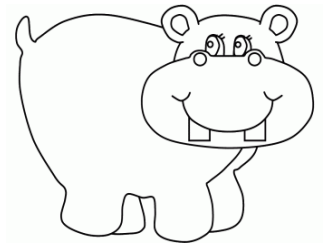
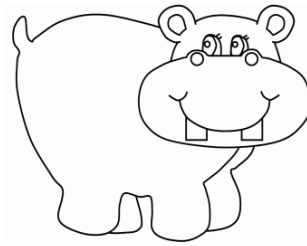
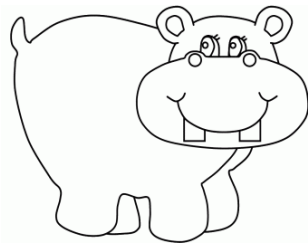
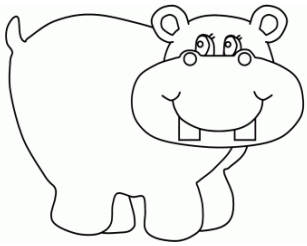
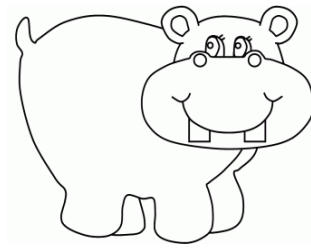
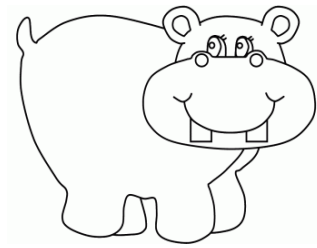
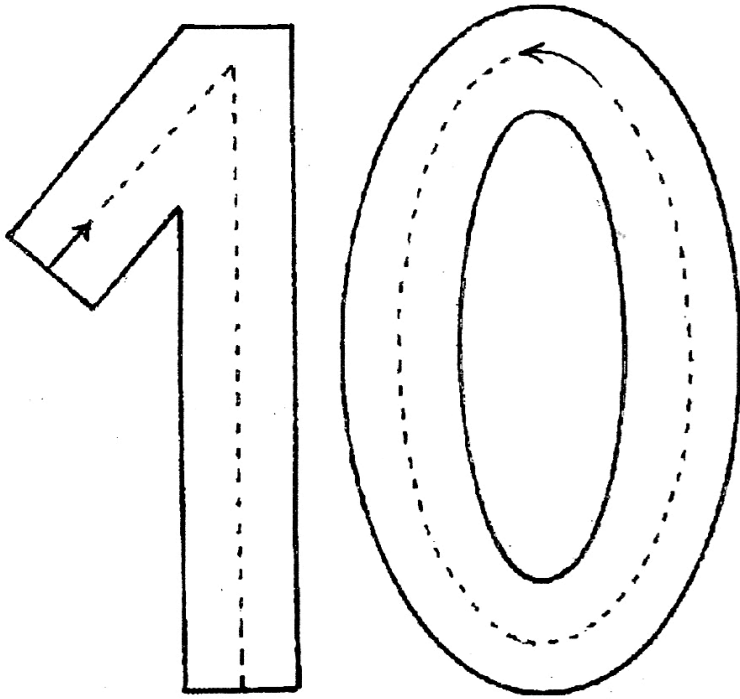

NÚMERO DIEZ

• Delineo correctamente con lápiz el número diez.

• Coloreo los gráficos.

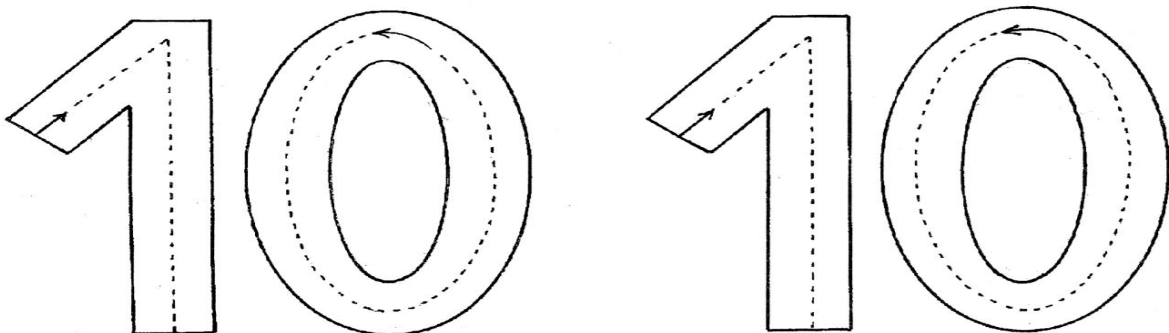
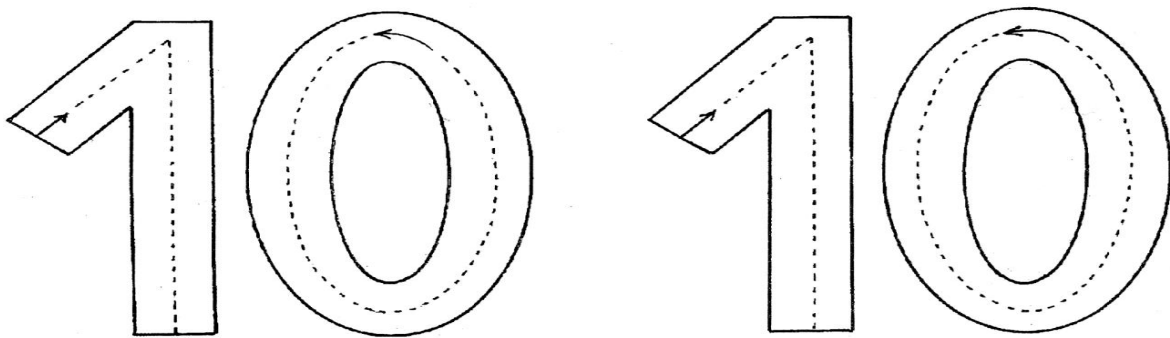
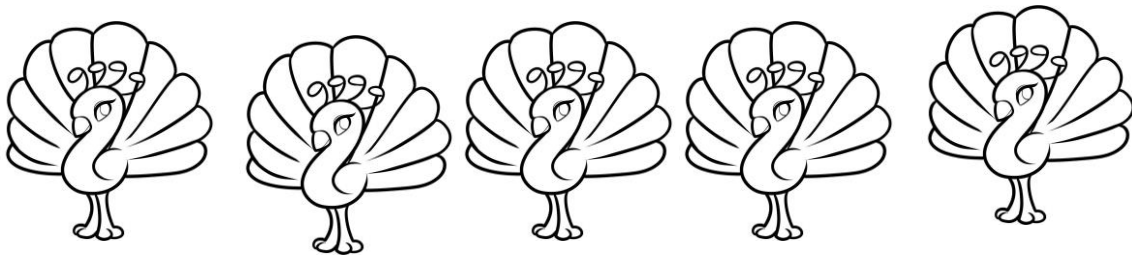
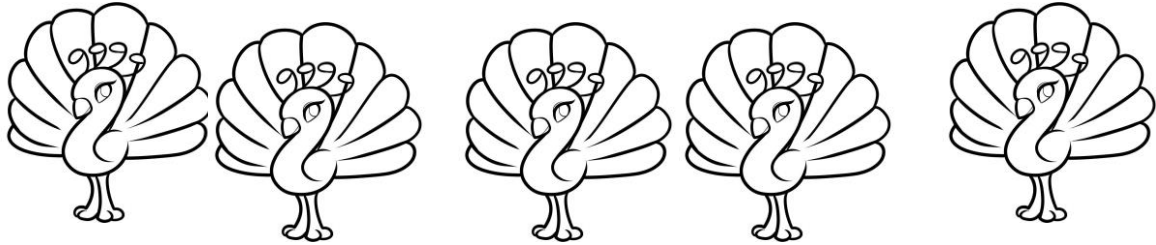

NÚMERO DIEZ

- Delineo con plumón sobre las líneas punteadas del número diez.

